

371 L Digital Chest Freezer

Model Number: HV-RCF371

INSTRUCTION MANUAL

AFTER SALES SUPPORT
(AU) 1300 886 649 (NZ) 0800 836 761



Contents

- 03 Important Safety Instructions**
- 07 Product Overview**
- 08 Getting Started**
- 10 Instructions**
- 13 FAQs and Troubleshooting Guide**
- 15 Other Useful Information**

Important Safety Instructions

READ CAREFULLY AND KEEP FOR FUTURE REFERENCE

Read this manual thoroughly before first use, even if you are familiar with this type of product. The safety precautions enclosed herein reduce the risk of fire, electric shock and injury when correctly adhered to. Keep the manual in a safe place for future reference, along with the completed warranty card, purchase receipt and carton. If applicable, pass these instructions on to the next owner of the appliance.



Pay particular attention to messages that follow this safety alert symbol or the words **DANGER, WARNING** or **CAUTION**. These words are used to alert you to a potential hazard that can seriously injure you and others. The instructions will tell you how to reduce the chance of injury and let you know what can happen if the instructions are not followed.



WARNING: Risk of fire

This symbol alerts you to take care as the appliance contains flammable materials: isobutane as refrigerant and cyclopentane as insulation blowing gas. While isobutane (R600a) is a gas with a high level of environmental compatibility, it is nevertheless flammable. Do not expose the appliance to high heat, sparks and open flames. During transport and installation, ensure that none of the components of the refrigerant circuit become damaged.

Refrigerant matters

WARNING: Do not damage the refrigerant circuit! Never use an appliance with a damaged refrigerant circuit! If the refrigerant circuit becomes damaged, avoid proximity to open fires and all types of heat and ignition sources. Thoroughly ventilate the room in which the appliance is located.

The room for installing the appliance must be at least 1m³ per 8g of refrigerant. The amount and type of refrigerant in the appliance can be found in the Technical Specifications on page 18 and on the appliance rating plate.

It is hazardous for anyone other than an authorised service person to service this appliance. In Queensland, the authorised service person **MUST** hold a Gas Work Authorisation for hydrocarbon refrigerants to carry out servicing or repairs which involve the removal of covers.

Responsible disposal

At the end of its working life, do not throw this appliance out with your household rubbish. Electrical and electronic products contain substances that can have a detrimental effect on the environment and human health if disposed of inappropriately. Observe any local regulations regarding the disposal of electrical consumer goods and dispose of it appropriately for recycling and recovery of the refrigerant and blowing agent. Contact your municipal authorities for advice on recycling facilities in your area.

WARNING! This refrigeration appliance contains flammable refrigerants and insulation blowing gases, which must be removed before disposal. Contact your municipal authorities for any codes or regulations concerning the disposal of such materials.

DANGER! Risk of child entrapment: When discarding this or another freezer, make sure to take off the door and leave the drawers in place so that children cannot easily climb in and get trapped inside.

Important Safety Instructions (Cont.)

To reduce the risk of fire, electric shock or injury, always follow basic safety precautions and accident prevention measures when using this appliance, including the following:

Electrical safety

- **Voltage:** Plug the appliance in a 220-240 V, 50 Hz, properly earthed power outlet, which must be in good working order. Make sure your outlet voltage and circuit frequency correspond to the voltage stated on the appliance rating label. Voltage fluctuations above the 220-240 V \pm 10% range will cause malfunction or damage.
- **Power connection:** Do not use an adaptor; do not use an extension cord. Plug the power plug directly into a power point that cannot easily be turned off accidentally, and that is easily accessible so you can switch it off when required.
- **Power cord:** Do not kink or damage the power cord. Do not leave it exposed or dangling. Secure it behind the appliance so no one steps on or places anything on the cord or against it. A squashed or damaged power plug may overheat and cause a fire.
- **Damaged cord:** Do not use a cord that shows cracks or abrasion damage along its length or at either end. Any damage to the cord may cause a short circuit, fire and/or electric shock. If the power cord is damaged, it must be replaced by the manufacturer or its service agent. Contact the after sales support line for advice.
- **Disconnection:** Never unplug the unit by pulling the cord. Always grip the plug firmly and pull straight out from the power point. Do not connect or disconnect the plug when your hands are wet.
- **Electrical work:** If the installation of this appliance requires any electrical work, make sure it is carried out by a qualified electrician.

Usage conditions and restrictions

- **Indoor domestic use only:** This appliance is intended for indoor domestic use only, which includes use in households, staff kitchen areas in shops, offices, in farm houses and in other working environments, use by clients in hotels, motels, bed and breakfast establishments, other residential type environments and in catering and similar non-retail applications. It is not suitable for industrial or commercial use.
- This appliance is intended to be used in household and similar applications, such as:
 - staff kitchen areas in shops, offices and other working environments;
 - farm houses and by clients in hotels, motels and other residential type environments;
 - bed and breakfast type environments;
 - catering and similar non-retail applications.
- **Intended purpose:** This product is a household freezer and is only suitable for food storage. Do not use it for other purposes, such as storage of blood, drugs or biological products. Do not use it for anything other than its intended purpose, and only use it as described in this manual. Do not attempt to alter or modify this appliance in any way.

Important Safety Instructions (Cont.)

- **Usage restrictions:** This appliance is not intended for use by persons (including children) with reduced physical, sensory or mental capabilities, or lack of experience and knowledge, unless they have been given supervision or instruction concerning the use of the appliance by a person responsible for their safety.
- **Children:** Supervise children to ensure they do not play with the appliance. Close supervision is necessary when any appliance is used by or near children. Never allow children to operate, play with or crawl inside or on top of the appliance.
- **Keep the top clear:** Do not place heavy objects on top of the freezer.
- **WARNING! Electrical appliances:** Do not place any appliances (e.g. microwave ovens, rice cookers, voltage regulators etc.) on top of the chest freezer. Do not use any electrical appliances (such as ice cream makers) inside refrigeration appliances, unless they are approved for this purpose by the manufacturer.
- **Personal safety:** Take care when closing the appliance to avoid getting your fingers caught in the small gaps between the freezer compartment and lid.

Cleaning and maintenance

- **Disconnect:** Unplug the appliance before cleaning or servicing. Failure to do so can result in electric shock, injury or death.
- **Flames:** Do not let open flames or ignition sources enter the appliance.
- **Flammable/explosive substances:** Never clean this appliance with flammable fluids. Do not store or use volatile, flammable or explosive substances such as aerosol cans with a flammable propellant in or close to this or any other appliance. The fumes can create a fire hazard or explosion.
- **Solvents:** Do not use solvent based cleaning agents or abrasives on the interior as these may damage or discolour the surfaces of the appliances.
- **WARNING!** Do not use **mechanical devices** or other means to accelerate the defrosting process, other than those recommended by the manufacturer. Never use a sharp or metal instrument to remove frost or clean the appliance. Use a plastic scraper, if necessary.
- **Service:** Do not attempt to repair, modify or replace any part of the appliance unless specifically recommended in this manual. Refer all other servicing to a qualified technician, or contact the after sales support centre for advice.

Installation (see page 8-9 for comprehensive installation instructions)

- **Heavy:** This appliance is heavy, take care when moving it. To avoid back or other injury, consider a two person lift or mechanical aid when installing it. Failure to do so can result in back or other injury. The appliance has two roll wheels on the right hand side for easy manoeuvrability.
- **WARNING: Ventilation:** To ensure proper ventilation, keep any ventilation openings, in the appliance enclosure or in the built-in structure, clear of obstructions. Ensure adequate air circulation around the appliance to prevent overheating.
- **Level:** Install the appliance level in order to ensure proper operation.

Important Safety Instructions (Cont.)

- **Location:** Choose a well ventilated indoor area that meets the following requirements:
 - **Ambient temperature:** The ambient temperatures must correspond to the climate class (T) indicated on the rating plate of the appliance: 18°C – 43°C.
 - **Floor surface:** The floor must be sturdy, level and strong enough to support the unit when it is fully loaded. We recommend you place a plastic mat underneath the appliance if your floor covering is sensitive to moisture.
 - **Areas to avoid:** Avoid areas where the appliance would be exposed to direct sunlight, sources of heat (stove, heater, radiator, oven, etc.), extreme cold ambient temperatures or excessive moisture and high humidity (such as outdoors or exposed to wind, rain water spray or drips). Installing it in the coolest area of the room will save energy consumption and running costs.

Product Overview

Scope of delivery

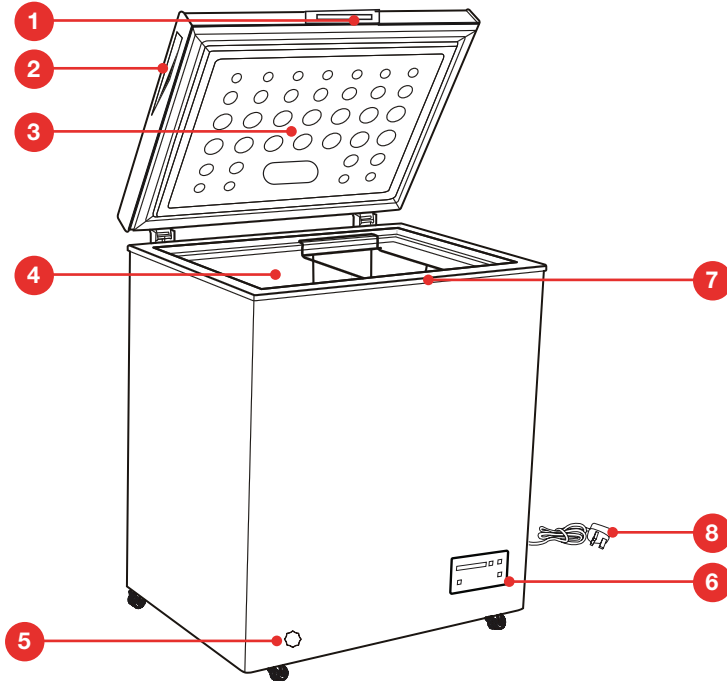

A Parts list

- 1 External handle (see page 16 for more information)
- 2 Recessed handle
- 3 Lid
- 4 Interior storage cabinet
- 5 Drainage hole
- 6 Thermostat control panel
- 7 Wire storage basket (removable)
- 8 Power cord and plug
- 9 Roll wheels (4: at the back corners) (not visible)
- 10 Plastic ice scraper (not shown)
- 11 Accessory kit (for external handle - not shown)

B Documentation (not shown)

Instruction manual
Quick Start Guide
Warranty certificate

NOTE:

Due to continued product improvement, images and illustrations in this manual may vary slightly from the product purchased. All images in this manual are for reference purposes only. Parts are not necessarily pictured to scale.

Getting Started

Unpacking

- **Unpacking:** This product has been packaged to protect it against transportation damage. Remove all packaging materials from around and inside the appliance, including any foam pads and tapes. Tear the protective film (if any) off the lid and cabinet.
 - **Packaging materials:** Keep the original packaging carton and materials in a safe place. It will help prevent any damage if the product needs to be transported in the future, and you can use it to store the appliance when it is not in use. In the event that the carton is to be disposed of, please recycle all packaging materials where possible. Plastic wrapping can be a suffocation hazard for babies and young children, so ensure all packaging materials are out of their reach and disposed of safely.
 - **Parts:** Check to ensure you have all the parts pictured opposite.
 - **Damage:** When unpacking, check the appliance carefully for damage. If it is damaged, do not install the appliance. Contact our after sales support centre for advice on examination or return of the damaged appliance.
 - **Power cord:** Unwind the power cord to its full length and inspect it for damage. Do not use the appliance if the appliance or its cord have been damaged or are not working properly. In case of damage, contact our after sales support line for advice on examination, repair or return of the damaged product.
 - **Read the manual:** Before installing your new freezer, read all safety instructions, especially the sections on installation and electrical safety. Then follow the installation instructions below and on the next page.
 - **Clean:** Make sure the freezer is disconnected from the power supply before wiping the interior surfaces and accessories with a damp cloth, moistened in lukewarm water with a mild detergent. This will remove any dust from transit and storage and help remove the typical smell of a brand new product. Then dry thoroughly.
- CAUTION:** Do not use harsh or abrasive detergents or powders as these will damage the finish.

Installation

- **Clearances:** Ensure that air can circulate freely around the back of the cabinet, which is necessary to cool the compressor and condenser. Allow at least 10 cm clear space at the back and sides of the unit, and 70 cm above (Fig. 1).
- **Overhanging wall units:** Ideally, the appliance should not be positioned below overhanging wall units. However, if it must be positioned below an overhanging wall unit, the distance between the top of the cabinet and the wall unit must be at least 1m so that you can comfortably open the lid and access the contents.

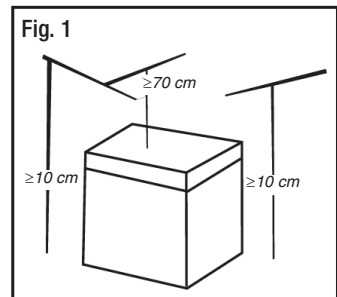

Getting Started (Cont.)

- **Upright, level position:** When installing the appliance, tilt it carefully – not more than 45° – and move it to its designated place; the freezer has roll wheels under the back corners of the base to help you position it into place.

Also ensure to install the appliance level, which is necessary for proper operation. Use the levelling feet at the front corners of the base for adjustment, if necessary.

Electrical connection

- **Before plugging in your new freezer, let it stand upright for at least 4 hours.** This will allow the refrigerant gases to settle into the compressor and reduce the possibility of a malfunction in the cooling system.
- **Earthing:** The appliance must be earthed. The plug of the power supply cord is equipped with a contact for this purpose. Do not under any circumstances cut or remove the third (earth) prong from the power cord. If the plug does not fit your outlet, consult a licensed electrician for advice to have the outlet changed.
- **Plug:** Before plugging the freezer into a dedicated, properly earthed wall outlet, ensure that your outlet voltage and circuit frequency correspond to the voltage stated on the rating label. Also ensure that the plug is not squashed or damaged by the back of the appliance. A squashed or damaged plug may overheat and cause a fire.
- **WARNING!** It must be possible to disconnect the appliance from the mains power supply; the plug must therefore be easily accessible after installation.
- **Power cord:** The freezer's power supply cord must not be lengthened. Secure the cord behind the unit. Do not leave it exposed or dangling to prevent injury and accidental disconnection from the power supply.
- **When first starting up, and after a period out of use, allow the unit to cool down for at least 4 hours before placing food in the cabinet.**

Instructions

Temperature control

The electronic control panel is located at the front of the freezer cabinet, in the bottom right corner (Fig. 2).

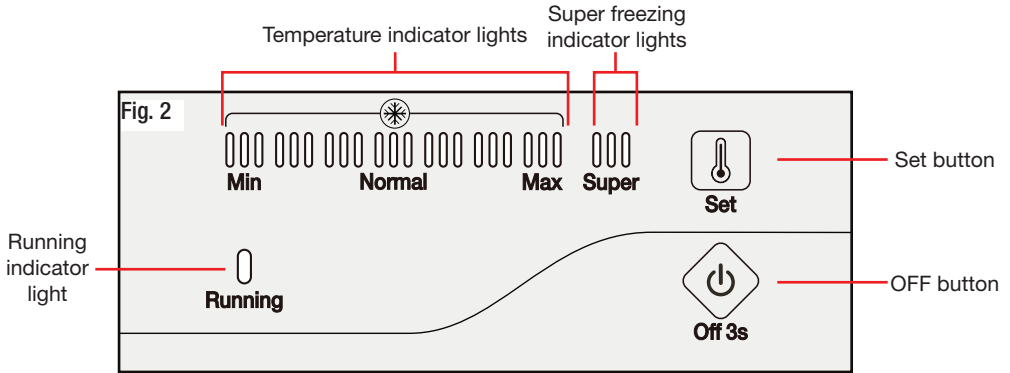

Switching on

- When the freezer is first connected to electricity, all indicator lights will flash once. The RUNNING indicator light will remain illuminated while the compressor is on.

Setting the Temperature

- To enter temperature setting mode, press the SET button.
- Repeatedly press the SET button to decrease the temperature. Each time the button is pressed, an additional indicator light will appear, moving from MIN to NORMAL to MAX, and then to SUPER, as the temperature decreases.
- The recommended temperature setting is NORMAL for everyday use.
- When you add quantities of non-frozen food to the freezer compartment, we recommend you use the SUPER freeze mode for fast cooling down of the cabinet. Continue to press the SET button to enter this fast freezing mode. All of the temperature indicator lights will switch on. The unit will automatically exit SUPER freeze mode once it has been running at this setting for 52 hours, unless it is changed manually beforehand.
- Press the SET button continue to cycle through the temperature levels.
- The temperature level will automatically set 5 seconds after the last button press.
NOTE: 30 minutes after the last button press, the illuminator light will lower to half luminance.
NOTE: If there is a power outage, when the freezer resumes working, it will automatically start in the previously set mode.

Switching off

- To turn the freezer off, press the OFF button for three seconds, before unplugging the unit from the power supply.

Instructions (Cont.)

IMPORTANT!

The unit may not work at the set temperature if the lid is opened too frequently. To ensure efficient operation, do not open the lid unnecessarily or for prolonged periods of time.

Instructions (Cont.)

The freezer compartment

The freezer compartment is suitable for freezing fresh food and long-term storage (up to three months) of frozen food. It is designed to operate in ambient (surrounding air) temperatures between 18°C and 43°C. For convenient access and organised storage, the freezer compartment is equipped with two wire storage baskets.

Freezing fresh food

- Only freeze fresh food that has been thoroughly cleaned.
- Do not store food uncovered in the freezer. Always use good quality, freezer-proof packaging to maintain food quality. Remove air from packages of solid food and seal bags tightly before freezing.
- Ensure that food placed in the freezer is dated and labelled. This will help you keep track of storage times.
- Keep portions small to ensure they are frozen (and subsequently defrosted) rapidly.
- Make sure that fresh, unfrozen food packages do not touch food that is already frozen, thus avoiding a temperature rise in the frozen food.
- When freezing food, do not push food together too much, leave some space for air to circulate around each item. Do not place packages directly against the back wall.
- When adding large amounts of fresh food to the freezer, set the freezer to Fast Freeze mode.
- Do not place hot foods or liquids which may evaporate in the freezer compartment.

Storing frozen food

- When buying frozen food, only buy quantities that you can store straight away; use an insulated container for your shopping and when you get home, place the food in the freezer immediately.
- When storing pre-packed, commercially frozen food, follow the food manufacturer's instructions for storing the food in a home freezer. Do not exceed any storage times listed on the packaging.
- Once you have opened a packet of frozen food, rewrap it airtight to prevent surface evaporation which causes drying or freezer burn.
- Do not place carbonated liquids, such as bottles of fizzy drink, in the freezer as the container could explode under pressure and damage the freezer. Do not freeze drinks in sealed containers.
- Do not refreeze food once it has been defrosted.
- Frozen food which has thawed accidentally should either be used immediately or thrown away. Alternatively, if the food is uncooked and has not been completely defrosted, it may be cooked and then refrozen.
- **CAUTION!** Do not remove items from the freezer if your hands are damp or wet as this could cause skin abrasions.

Instructions (Cont.)

Saving energy

- Locate the freezer in the coolest area of the room, away from heat-producing appliances and out of direct sunlight.
- Let hot foods cool to room temperature before placing them in the freezer. Overloading the freezer forces the compressor to run longer.
- Be sure to wrap foods properly, and wipe containers dry before placing them in the freezer. This cuts down on frost build-up inside the unit.
- Do not line the storage basket with aluminium foil, wax paper or paper towelling. Liners interfere with cold air circulation, making the freezer less efficient.
- Do not pack food packages close together as this prevents air circulating.
- Organise and label food to reduce lid openings and extended searches. Remove as many items as needed at one time and close the lid as soon as possible.

Temperature sensor fault alarm

- If the temperature sensor is disconnected or shorted out, the temperature indicator bar will flash from left to right every 0.5 seconds. Please contact our after sales support centre for more information.

Power failure

- Most power failures are corrected within a few hours and should not affect the temperature inside your freezer, if you minimise the number of times the lid is opened. However, if the power is going to be off for a longer period of time, you need to take proper steps to protect your food.
- Do not refreeze frozen food without checking its condition first. If in doubt, discard the food. Do not refreeze food that has thawed completely.
- The appliance has a power cut memory, which will ensure that the appliance starts to work again to the set parameters once the power has been restored.

Going away?

- **Short vacation:** Leave the freezer operating during vacations of less than a month.
- **Long vacation:** If you are not going to use the freezer for longer periods, remove all food and unplug the power cord. Clean and dry the interior thoroughly. To prevent odour and mould growth, leave the lid open slightly, blocking it open, if necessary.
CAUTION: Restrict children's access to the room with the open freezer to avoid creating a child entrapment risk.

Moving the freezer

- Once the freezer is running, do not move it under normal circumstances.
- When you must move the freezer, please ensure it is disconnected from the power supply. Remove all food from inside the freezer, securely tape down the baskets and tape the lid shut. Protect the outside of the unit with a blanket or similar soft material. Use the two roll wheels at the right front and back corners of the appliance to help you move it, but do not tilt the freezer more than 45°. Make sure the freezer stays secure in the upright position during transportation.

FAQs and Troubleshooting Guide

If you experience a problem with your chest freezer, check in the following table for solutions to help you solve the problem. If after these checks you still have a problem with your freezer, contact our after sales support line for advice.

CAUTION: Before troubleshooting, disconnect the power supply. Any troubleshooting not mentioned here may only be carried out by a qualified professional.

Problem	Possible cause
"E2" appears on the display window.	<ul style="list-style-type: none"> The temperature sensor has failed. Please call our after sales support centre for advice.
The freezer does not work.	<ul style="list-style-type: none"> It is not plugged in. The circuit breaker tripped or a blown fuse. The temperature is incorrectly set.
The compressor turns on and off frequently. Does that indicate that there is a problem?	<ul style="list-style-type: none"> The room temperature (weather) is hotter than on other days. A large amount of food has been added. The lid is being opened too often. The lid is not closed completely. The temperature control is set incorrectly. The lid gasket does not seal properly. The freezer does not have the correct ventilation clearances. The freezer has recently been disconnected for a period of time. At least 2 hours are required for the freezer to cool down with the temperature set to the coldest level.
The temperature inside the freezer is too warm.	<ul style="list-style-type: none"> The temperature control is set too warm. Adjust the temperature and allow several hours for the temperature to stabilise. The lid is kept open too long or is opened too frequently. Warm air enters the freezer every time the lid is opened. Open the lid less often. The lid is not closed completely. The lid gasket does not seal properly. A large amount of warm/hot food has been added recently. Wait until the freezer has had a chance to reach its selected temperature. The freezer has recently been disconnected for a period of time. At least 2 hours are required for the freezer to cool down with the temperature set to the coldest level.
The temperature inside the freezer is too cold.	<ul style="list-style-type: none"> Set the temperature to a few degrees higher, if it is set to maximum coldness, and allow several hours for the temperature to stabilise.

FAQs and Troubleshooting Guide (Cont.)

<p>There is an unpleasant odour inside the freezer cabinet.</p>	<ul style="list-style-type: none"> • Ensure food with strong odours is tightly wrapped/packaged before freezing it. • Check and ensure that there is no spoiled food and that the freezer cabinet is clean.
<p>The temperature of the external freezer surface is warm.</p>	<ul style="list-style-type: none"> • The exterior freezer walls can be warmer than room temperature. This is normal while the compressor works to transfer heat from inside the freezer cabinet.
<p>There is a popping or cracking sound when the compressor comes on. Does that indicate a problem with cooling performance?</p>	<ul style="list-style-type: none"> • Metal parts undergo expansion and contraction, just as hot water pipes. This is normal. The sound will level off or disappear as the freezer continues to run.
<p>There is a bubbling or gurgling sound, like water boiling.</p>	<ul style="list-style-type: none"> • Refrigerant (used to cool the freezer) is circulating throughout the system. This is normal.
<p>There are vibrations; what is causing them? How can I stop the vibrations?</p>	<ul style="list-style-type: none"> • Check to ensure that the freezer is on a level surface. • The floor is uneven or weak. The freezer rocks on the floor when it is moved slightly. Be sure your floor can adequately support the freezer. • Put a piece of metal or timber underneath parts of the freezer to level it. • The freezer is touching the wall. Re-level the freezer and move it away from the wall.
<p>Moisture forms on the inside freezer walls.</p>	<ul style="list-style-type: none"> • Hot and humid weather increases the internal rate of frost build-up. This is normal. • The lid is slightly open. • The lid is kept open too long, or is opened too frequently. Open the lid less often. • The lid is not sealed properly.
<p>Moisture forms on the outside of the freezer.</p>	<ul style="list-style-type: none"> • The lid is slightly open, causing cold air from inside the freezer to meet warm, moist air from the outside. • Condensation may also form during periods of high humidity. Wipe it dry with a soft cloth.
<p>The lid will not close properly.</p>	<ul style="list-style-type: none"> • The freezer is not on a level surface. • The gasket is dirty. • A storage basket is out of position.
<p>The lid is difficult to open.</p>	<ul style="list-style-type: none"> • If the lid has just been closed, wait a moment before opening it again.

Other Useful Information

WARNING!

To reduce the risk of electric shock or injury, always disconnect the appliance from the power supply before defrosting or cleaning it.

Defrosting the freezer

When the unit is run in “Freezer” mode, its interior walls will become progressively covered with frost. For efficient operation and minimum energy consumption, it is important that this frost layer is removed regularly. You may use the supplied plastic ice scraper to remove a thin layer of frost — do NOT use a metal implement.

If the frost on the freezer walls has built up to about 3–4 mm thickness, the unit should be defrosted properly, as described below. Preferably, choose a time when your stock of frozen food is low.

- Unplug the freezer and remove the food and storage basket. (Keep any frozen food temporarily in a freezer or cooler bag to keep defrosting to a minimum.)
- During defrosting, any ice and frost that has accumulated will melt into the freezer cabinet. To drain the water, you will need to remove the drain plug from the freezer.
- Place a shallow tray and some dry towels underneath the outer drain plug for the water to drain into. Then slightly pull out the plug and rotate it 180 degrees (Fig. 3) so the water can flow out the hole.
- Defrosting usually takes a few hours. To defrost faster keep the lid open. Check the tray occasionally so the water does not overflow. Wipe any remaining water out of the freezer cabinet with a dry, soft cloth.
- When done, clean the appliance as described on the next page. Alternatively, push the drain plug in and also re-plug the drain plug inside the freezer cabinet. Clean and/or dry all interior freezer surfaces thoroughly, then reset the freezer temperature and plug in the freezer to restart it.

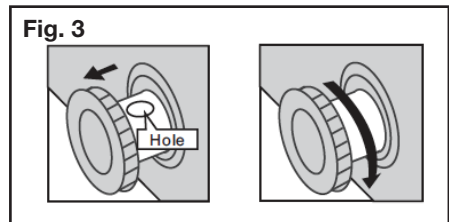

WARNING!

- Never use sharp or metallic tools to scrape off frost from the evaporator as you could damage it. To scrape ice off surfaces, use a plastic scraper.
- Never use boiling water to accelerate defrosting as it may damage the plastic parts.

Other Useful Information (Cont.)

Installing the External Handle

- To install the external handle of this appliance, gather the external handle and four screws from the accessory bag.
- Then, fix the handle base (a) to the lid of the appliance using these screws (b) (Fig. 4).

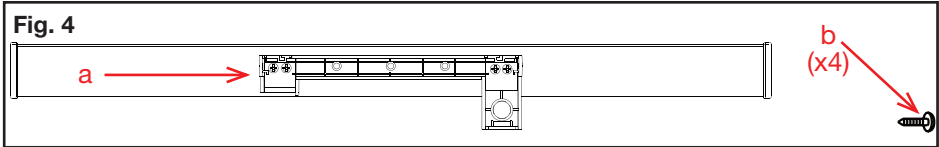

- Insert the handle (c) into the handle base, gently pressing until you hear a click (Fig. 5).

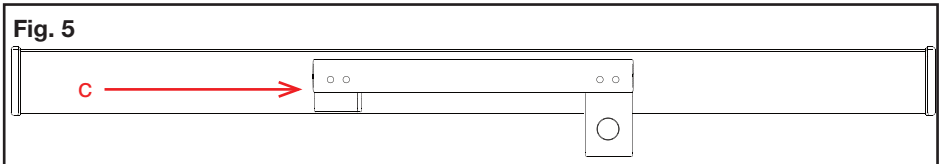

- After the handle has been assembled on the door, fasten the decorative cover (d) onto the handle (Fig. 6). Ensure all screws are tightened and all parts are correctly and securely in the correct place.

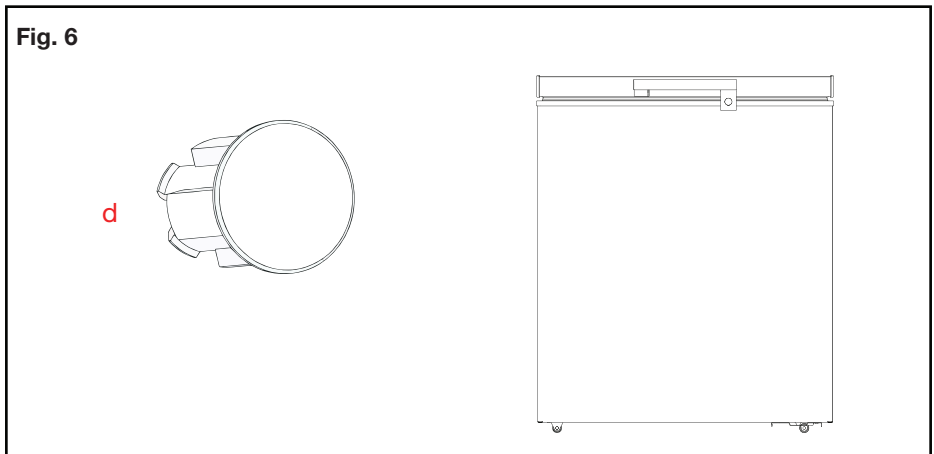

Other Useful Information (Cont.)

Cleaning the freezer

For hygienic reasons clean the appliance interior and accessories regularly. We recommend cleaning the freezer after defrosting it.

- Make sure the unit is unplugged from the power supply and all food and the storage basket are removed.
- Wash the inside surfaces and the interior accessories with a damp, warm cloth moistened in a water and baking soda solution. The solution should be about two tablespoons of baking soda to one litre of water. Rinse and wipe dry with a soft cloth.
- Clean the outside of the unit with a damp, well wrung out cloth, keeping the area around the control panel dry. Keep the lid gasket (seal) clean.
- If used as a refrigerator, regularly examine the drain in the appliance for defrost water and clean the drain, if necessary. If the drain is blocked, water will collect in the base of the appliance.
- After cleaning, push the drain plug in and also re-plug the drain plug inside the cabinet. When everything is dry, place appliance back into service.
- Allow approximately two hours for the cabinet to cool down again (depending on how long was disconnected from the power). If the appliance is used as a freezer, you can speed up the cooling down time by setting the control panel to “Super Freezing” mode for a few hours before resetting it to your usual freezer mode and temperature.

WARNING!

- Never clean the unit with an abrasive, acid, oil or solvent-based cleaning agent, or with abrasive pads or scourers. Never use flammable fluids or sprays for cleaning as the fumes from these substances can create a fire hazard or explosion.
- Never clean the appliance with a steam cleaner. Moisture could accumulate in the electrical components, danger of electric shock! Hot vapours can lead to the damage of plastic parts.
- The appliance must be completely dry before it is placed back into service.
- Ethereal oils and organic solvents can attack plastic parts, e.g. lemon juice or the juice from orange peel, butyric acid, or cleansers that contain acetic acid. Do not allow such substances to come into contact with the appliance parts.

Storage

If the appliance is not going to be used for an extended period of time, unplug it from the power supply and store the clean and dry appliance in the original packaging to protect it from dust.

Other Useful Information (Cont.)

Service and repair

Do not attempt to alter or modify this appliance in any way, or to repair or replace any part unless it is specifically recommended in this manual. All other servicing should be referred to a qualified technician; contact our after sales support centre.

Technical specifications

Model	HV-RCF371
Rated Voltage	220-240 V~
Rated Frequency	50 Hz
Rated Current	1.65 A
Total Input Power	180 W
Climate class	T
Capacity	371 L
Refrigerant	R600a, 66 g
Insulation blowing agent	Cyclopentane
Net weight (approx.)	43 kg
Dimensions (approx.)	1300(W) x 700(D) x 845(H) mm

Compliance

This appliance has been fully tested and meets all requirements as set out by standards AS/NZS 60335.1 and AS/NZS 60335.2.24.



The RCM Mark (Regulatory Compliance Mark) indicates that the product complies with the relevant guidelines of the ACMA as well as corresponding government requirements for the safety of electrical devices.

T

This marking indicates that the appliance is suitable for use in tropical climates under ambient temperatures of 18 °C to 43 °C.

Other Useful Information (Cont.)

Responsible disposal

- At the end of its working life, do not throw this appliance out with your household rubbish. Electrical and electronic products contain substances that can have a detrimental effect on the environment and human health if disposed of inappropriately. Observe any local regulations regarding the disposal of electrical consumer goods and dispose of it appropriately for recycling and recovery of the refrigerant and blowing agent. Contact your municipal authorities for advice on recycling facilities in your area.
- This refrigeration appliance contains flammable refrigerants and insulation blowing agents, which must be removed before disposal. Contact your municipal authorities for any codes or regulations concerning the disposal of such materials.
- **DANGER! Risk of child entrapment:** When discarding the freezer, make sure to take off the lid so that children cannot easily climb in and get trapped inside.



Packaging materials are recyclable. Please dispose of them responsibly for recycling.



At the end of its working life, do not throw this appliance out with your household waste. Electrical and electronic products contain substances that can have a detrimental effect on the environment and human health if disposed of inappropriately. Observe any local regulations regarding the disposal of electrical consumer goods and dispose of it appropriately for recycling.

Contact your local authorities for advice on recycling facilities in your area. Or find recycling scheme services listed on Planet Ark's website at www.recyclingnearyou.com.au, or call Planet Ark on 1300 733 712.

This page has been left blank intentionally.

This page has been left blank intentionally.

This page has been left blank intentionally.

Warranty returns

Should you for any reason need to return this product for a warranty claim, make sure to include all accessories with the product.

Product does not work?

If you encounter problems with this product, or if it fails to perform to your expectations, make sure to contact our After Sales Support Centre on (AU) 1300 886 649 or (NZ) 0800 836 761 for advice.

For an electronic copy of this manual, please contact our after sales support centre.

Distributed by Tempo (Aust) Pty Ltd ABN 70 106 100 252
PO BOX 132 Frenchs Forest, Australia NSW 1640
Customer Helpline:
(AU) 1300 886 649 (NZ) 0800 836 761
Web Support: tempo.org/support